

Bx2

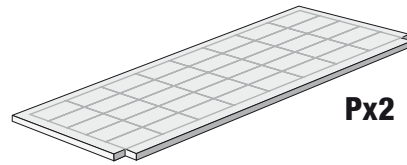

Px2

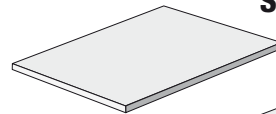

Sx2

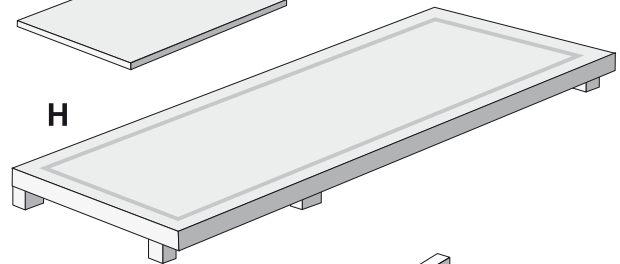

H

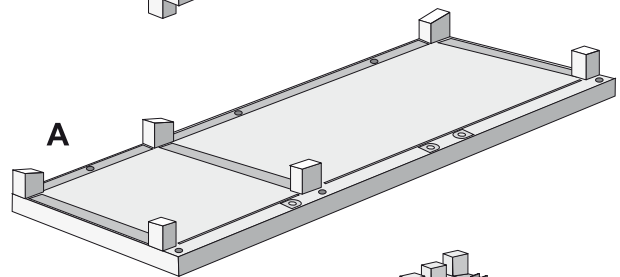

A

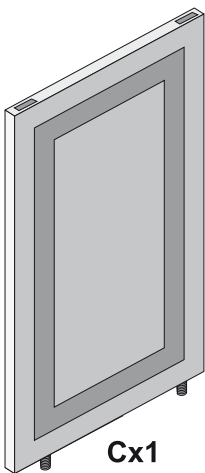

Cx1

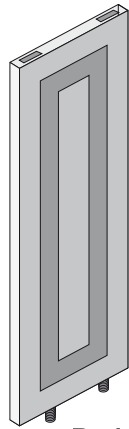

Dx1

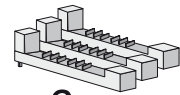

G

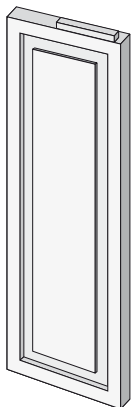

Ex3

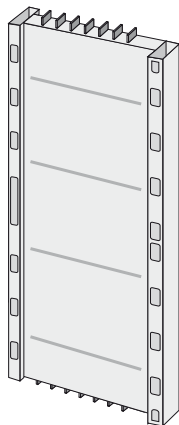

lx1

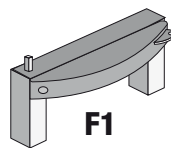

F1

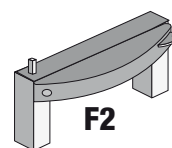

F2

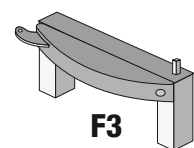

F3

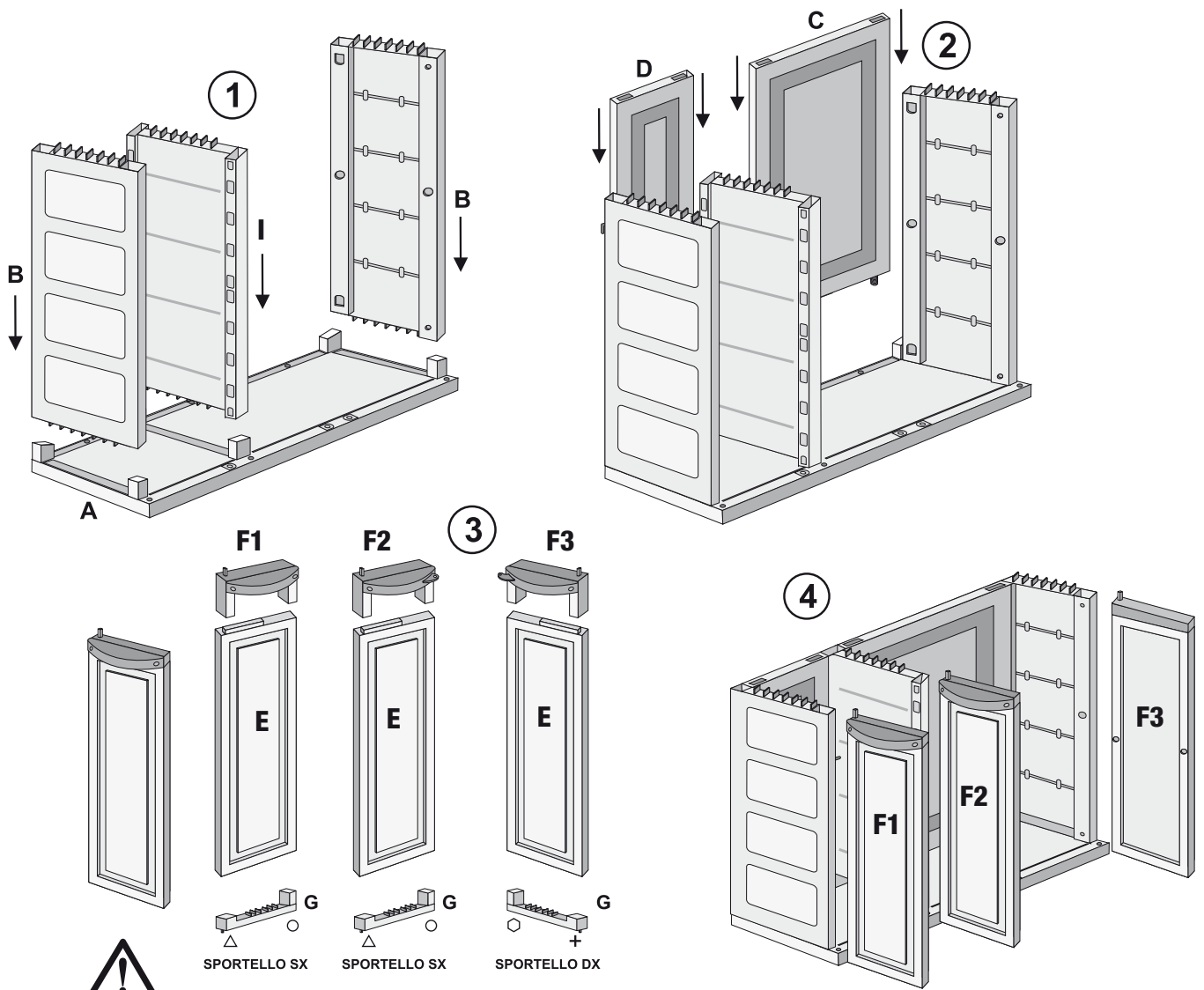

Attenzione! Posizionare il pezzo G in maniera da far corrispondere i simboli con il pezzo E.

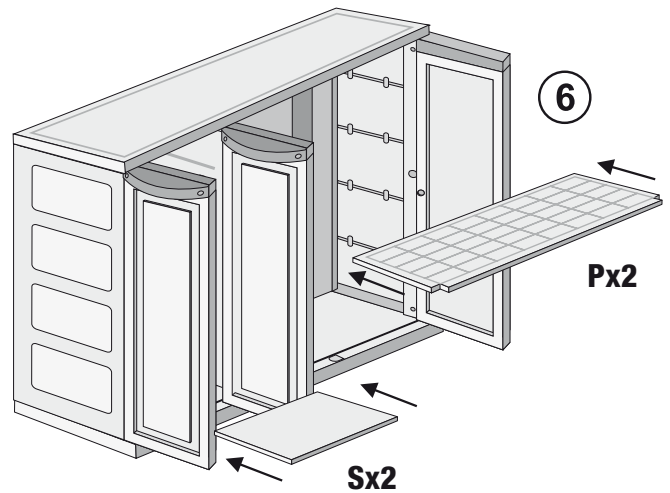
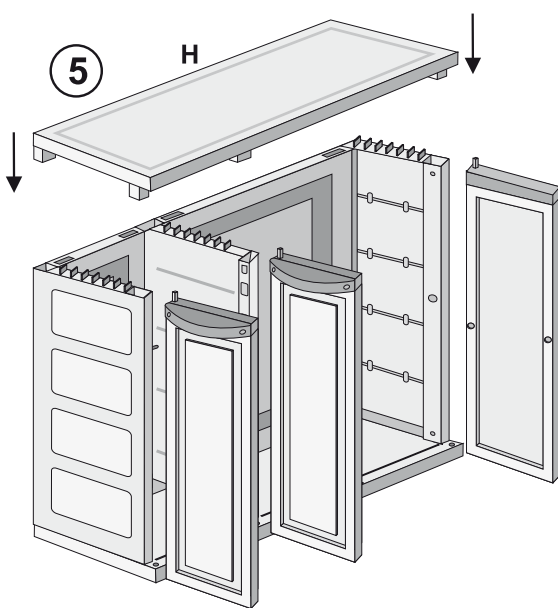

STAMPAGGIO MATERIALI PLASTICI

TRIOPLAST srl - 53049 Torrita di Siena (SI) - Loc. Capannone - Italy
 Tel. +39.0577.624108 Fax +39.0577.623284
 www.trioplast.it info@trioplast.it

TAGLIANDO DI CONTROLLO

OPERATORE

DATA